

な

な

な

な

な

な

な

な

な

なにぬねの

なまえ

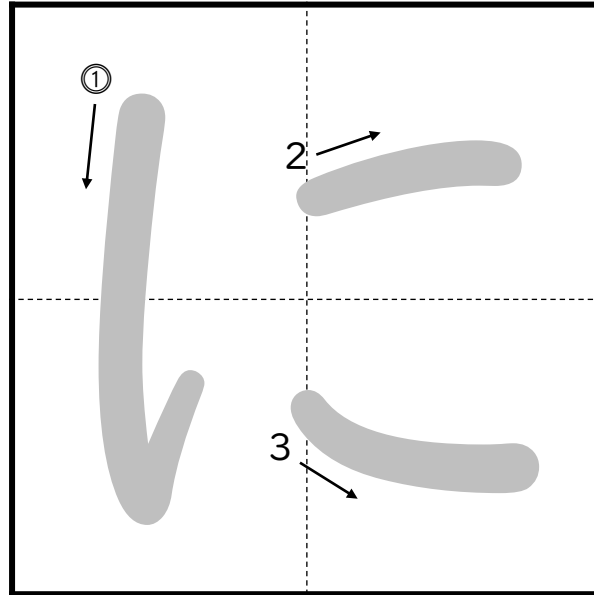
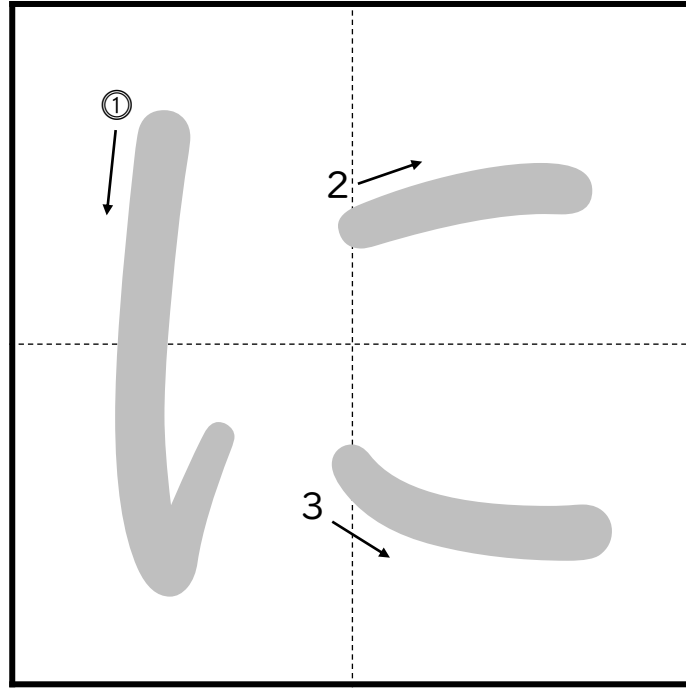
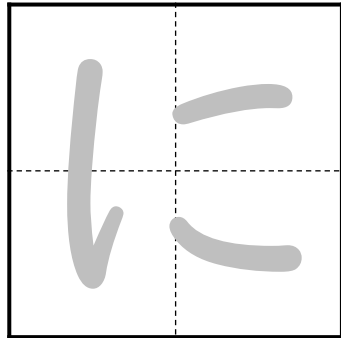
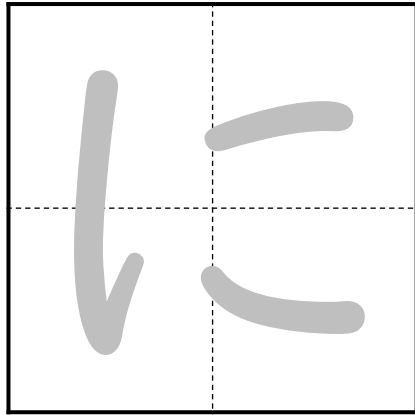
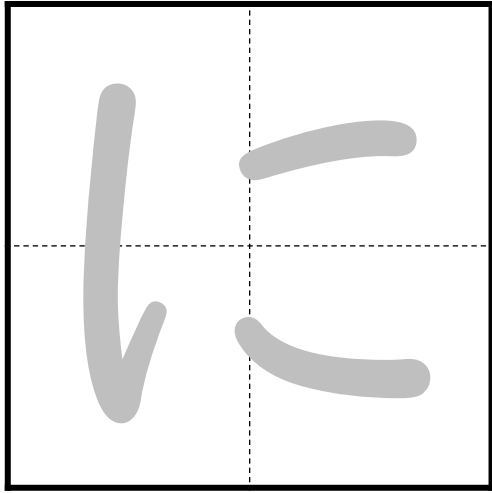
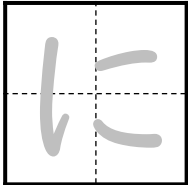
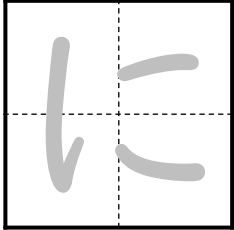
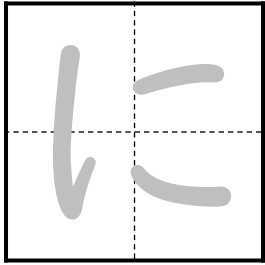
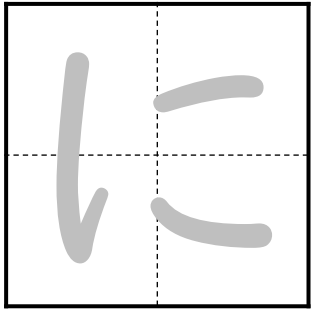

な  
に  
ぬ  
ね  
の

な  
ま  
え

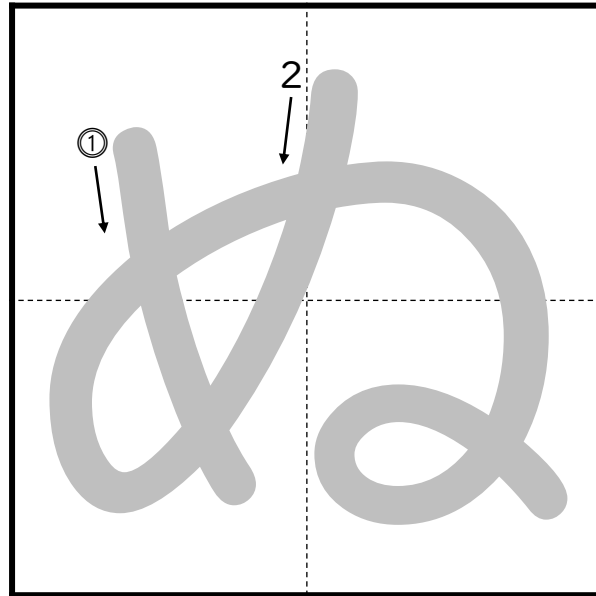
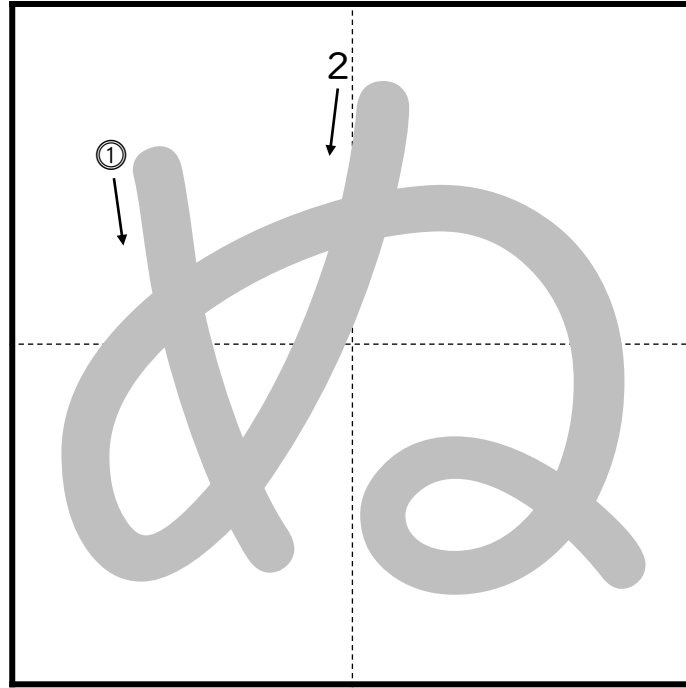
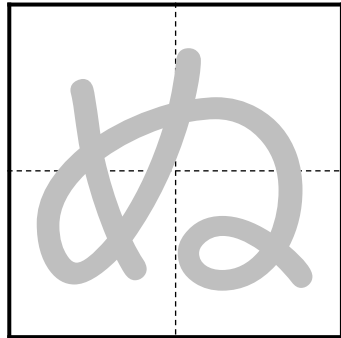
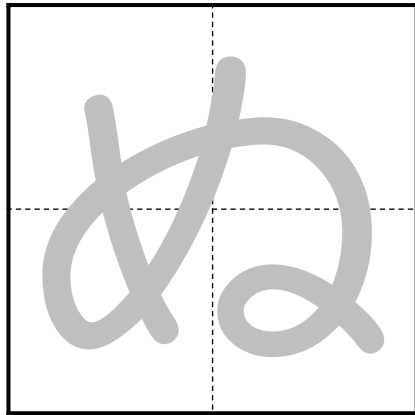
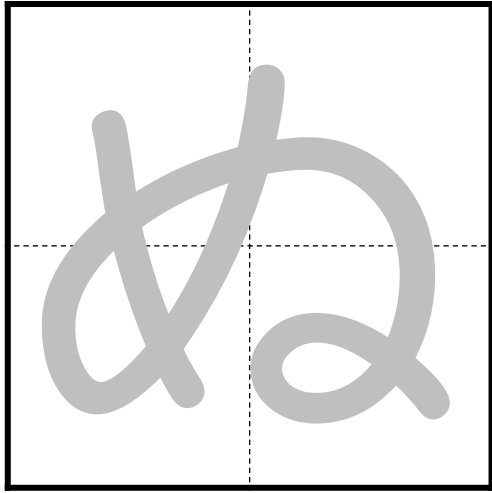
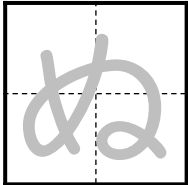
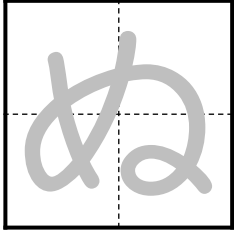
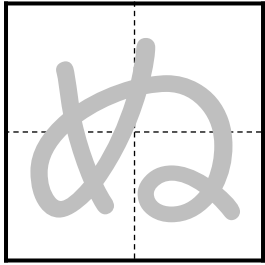
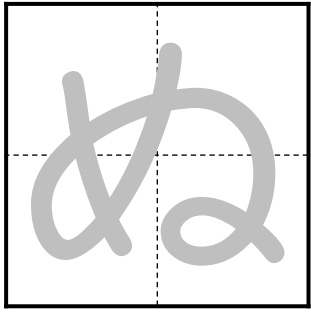

な  
にぬ  
ね  
の

な  
ま  
え

ね

ね

ね

ね

ね

ね

ね

ね

ね

なにぬねの

なまえ

Blank space for writing a name.

なにぬねの

